

IoT Data from a day's work with the 8015F and MD270 deck

Detected attachment

Detected motors
7

Detected attachment:
Mowingdeck

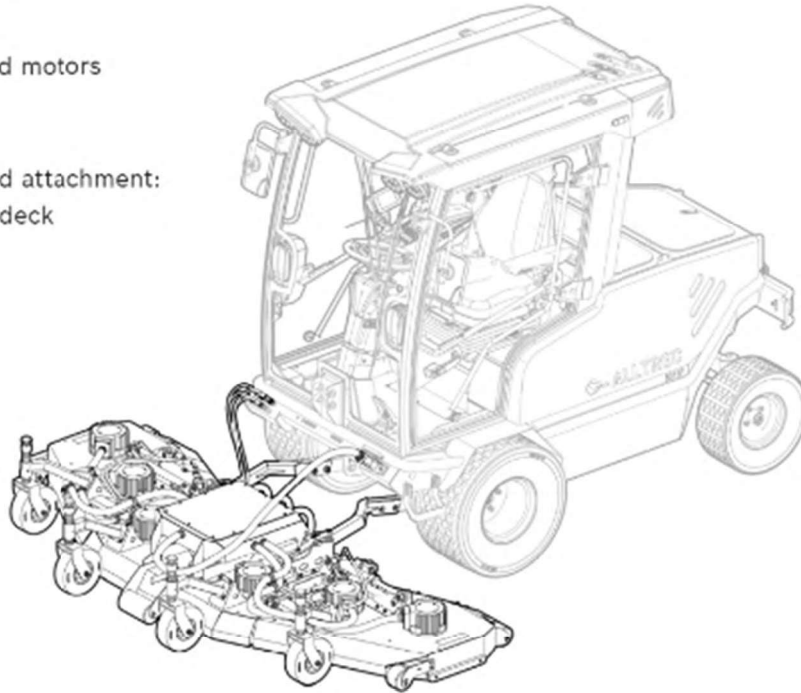

Tour map

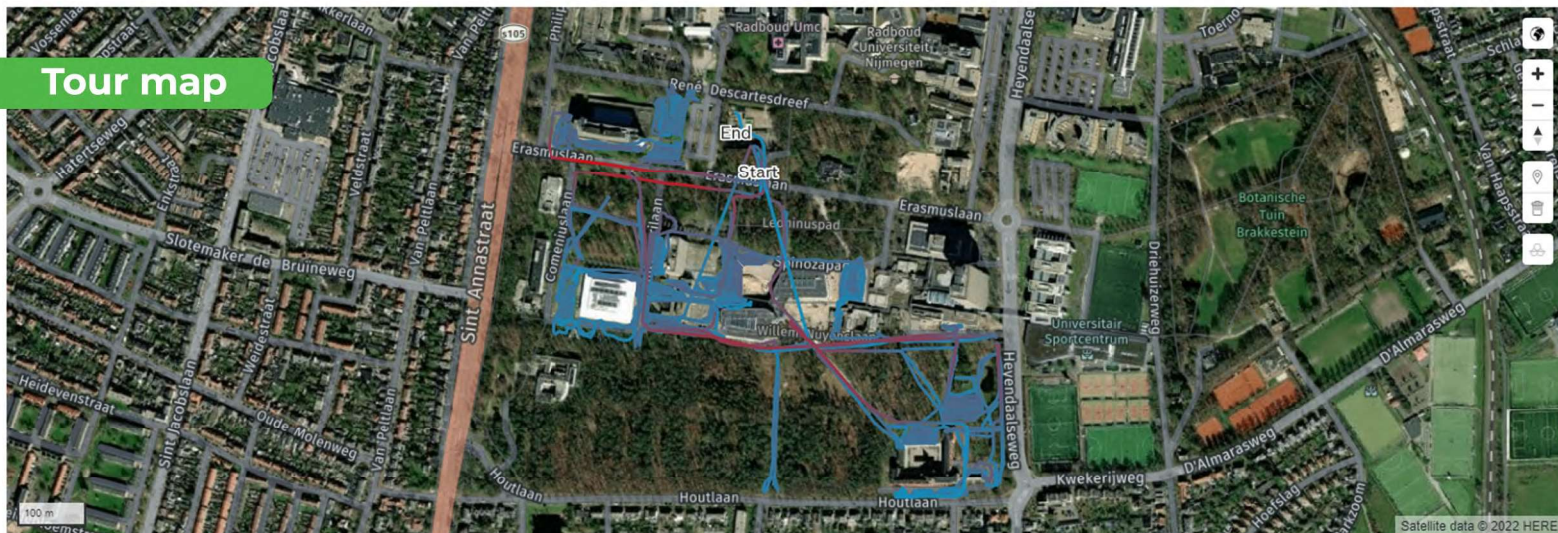

Drive speed

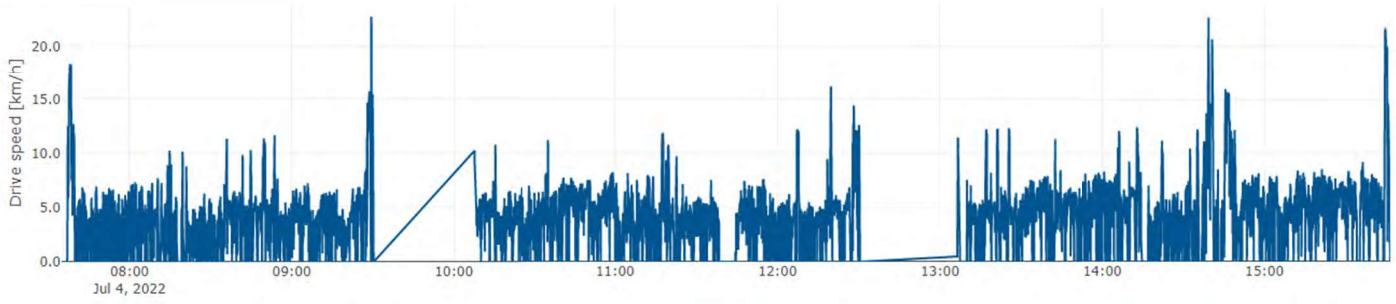

RMS motor currents

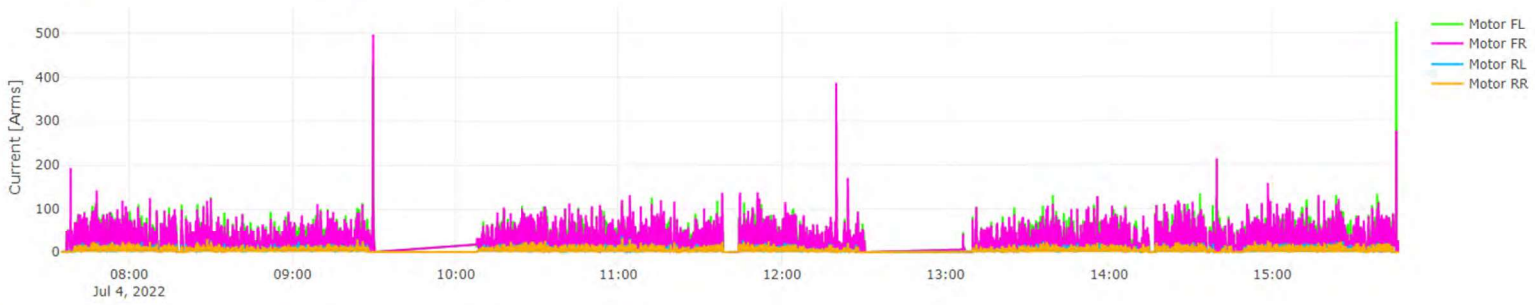

Traction motor temperatures

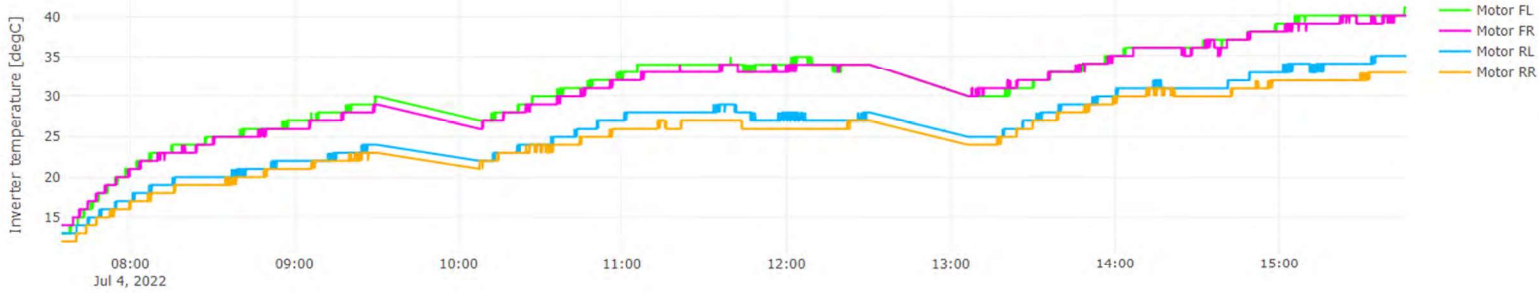

Traction inverter temperatures

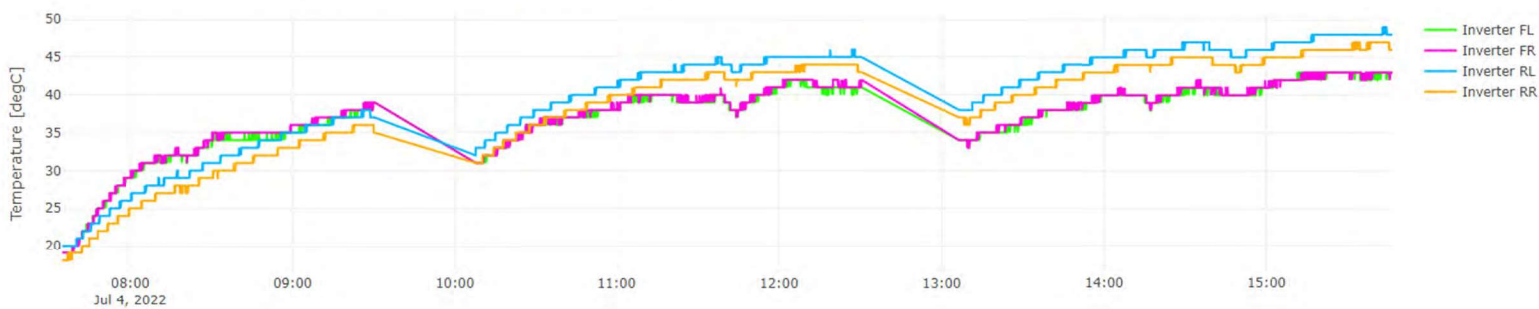



Attachment ON/OFF

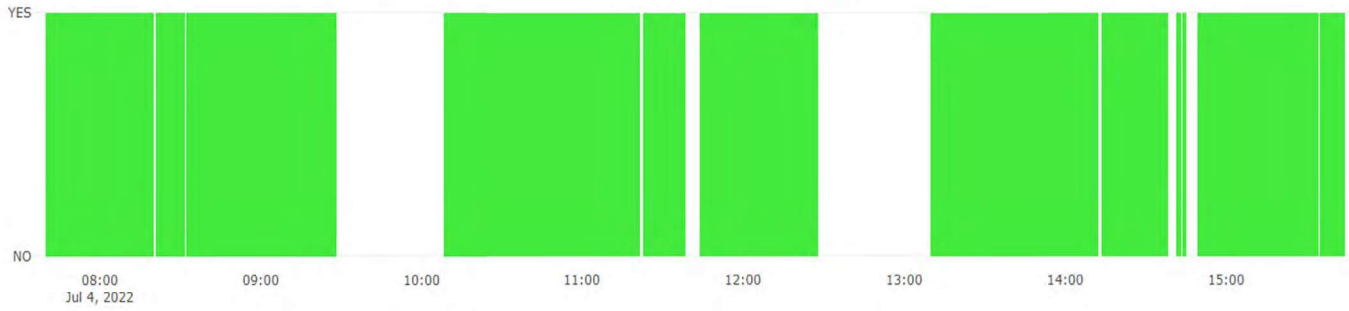

Attachment motor speed(s)

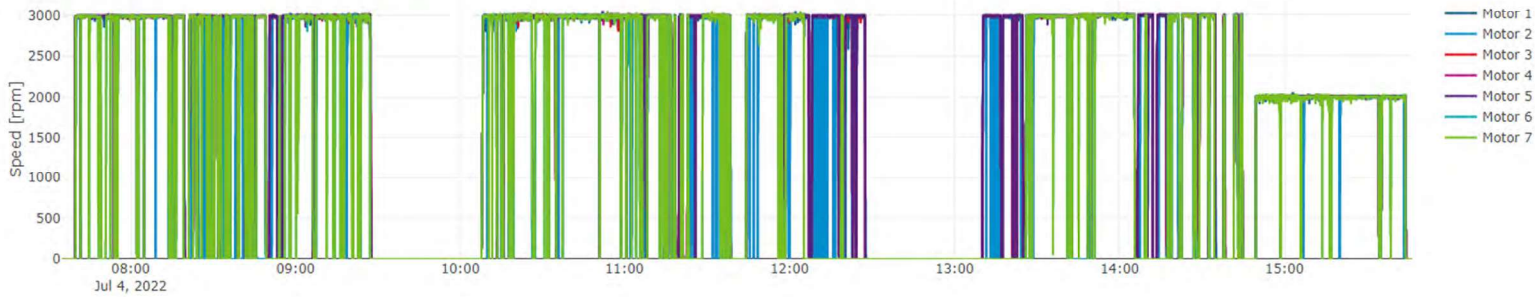

RMS Motor current(s)

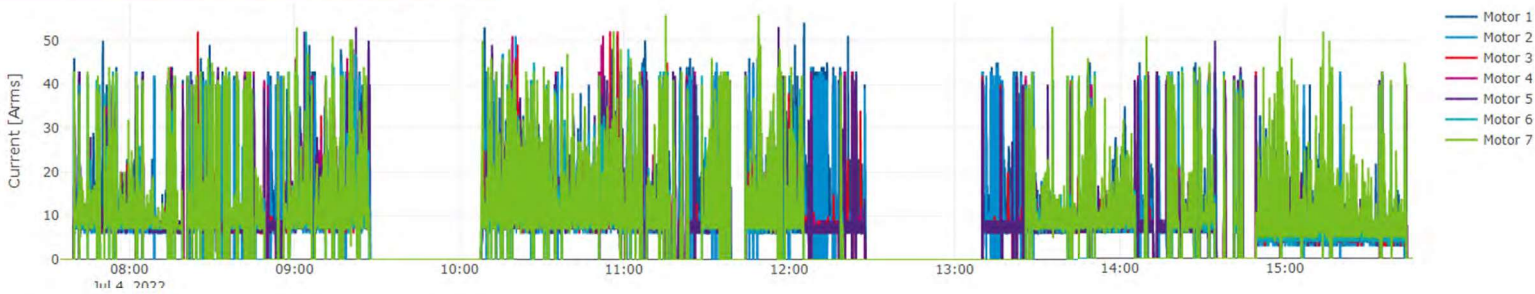

Motor temperature(s)

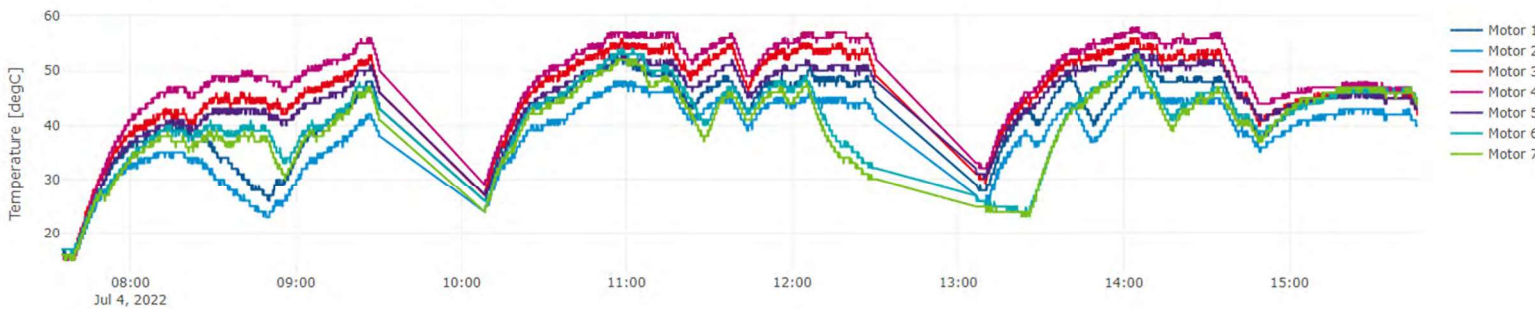

Inverter temperature(s)

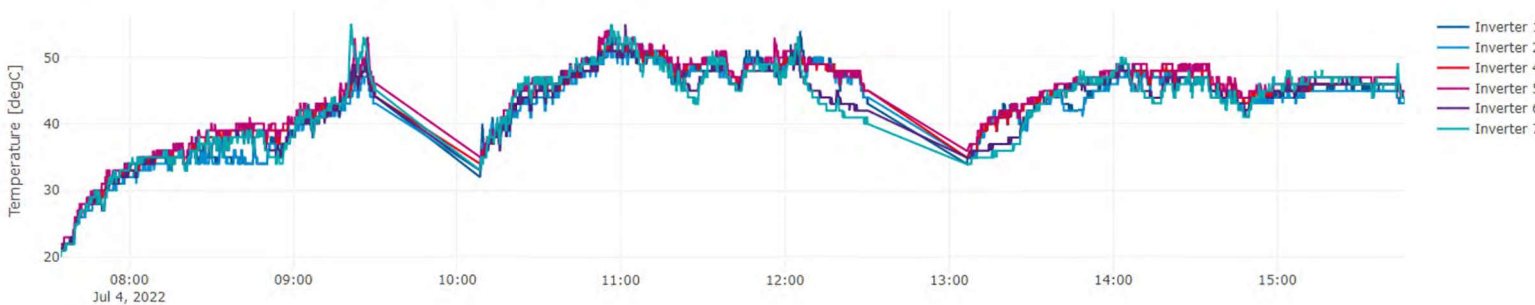



Hydraulic pump motor current

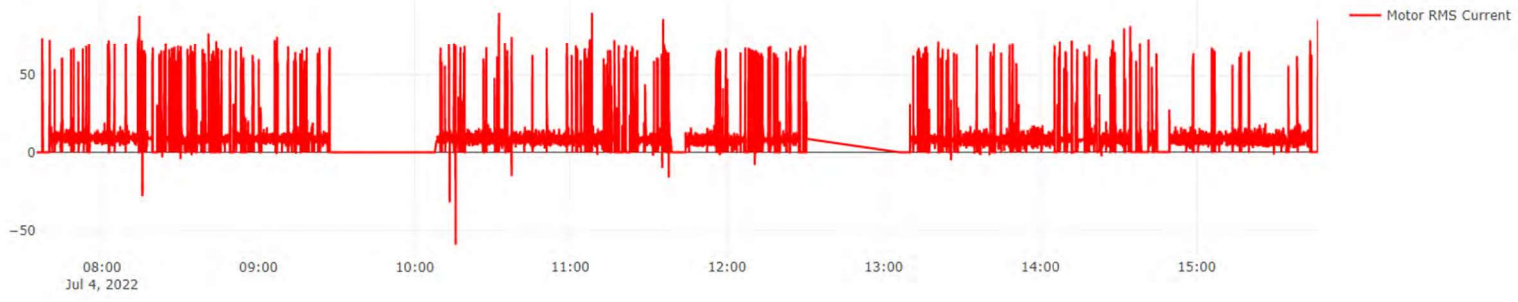

Hydraulic pump temperatures

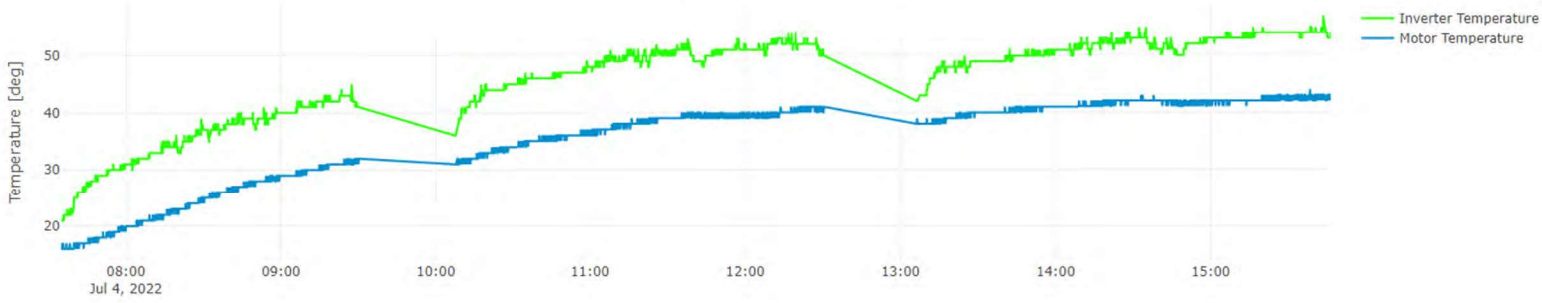



Battery

Battery SOC timeline

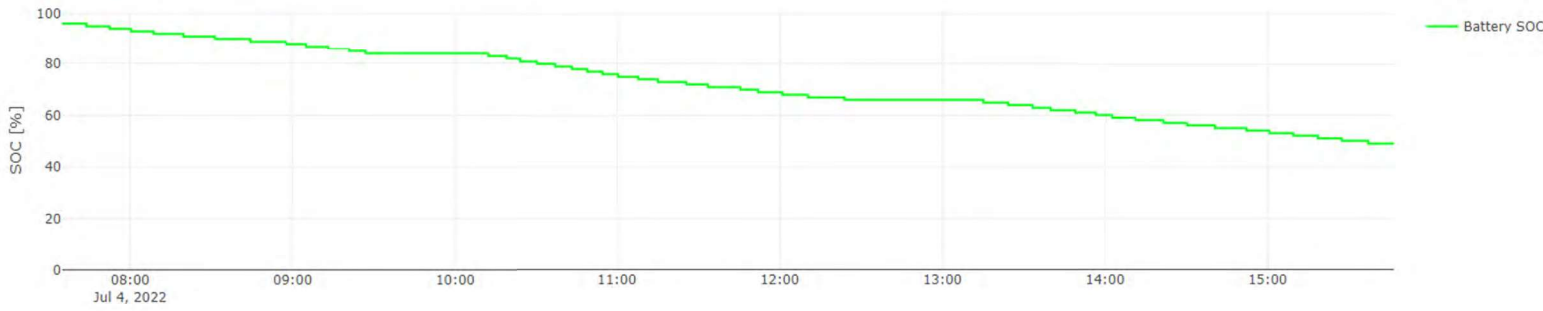

Battery temperature

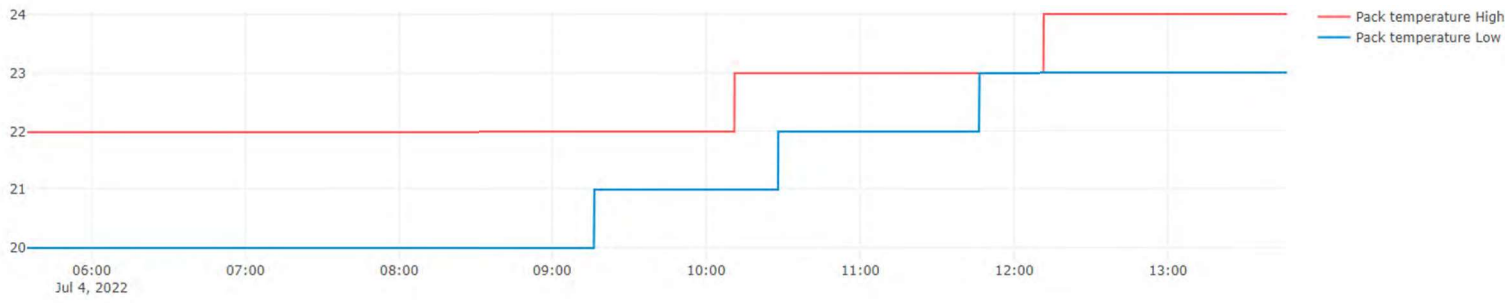

Battery cell voltage

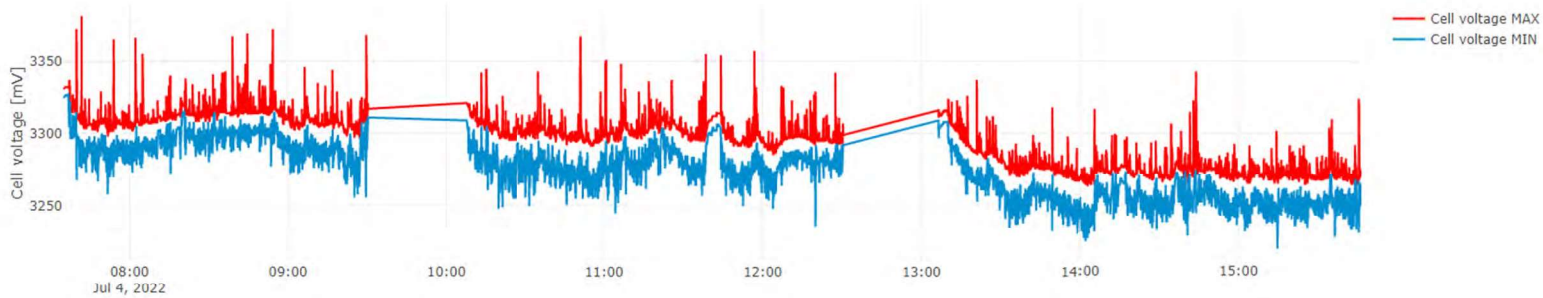

EPAS current

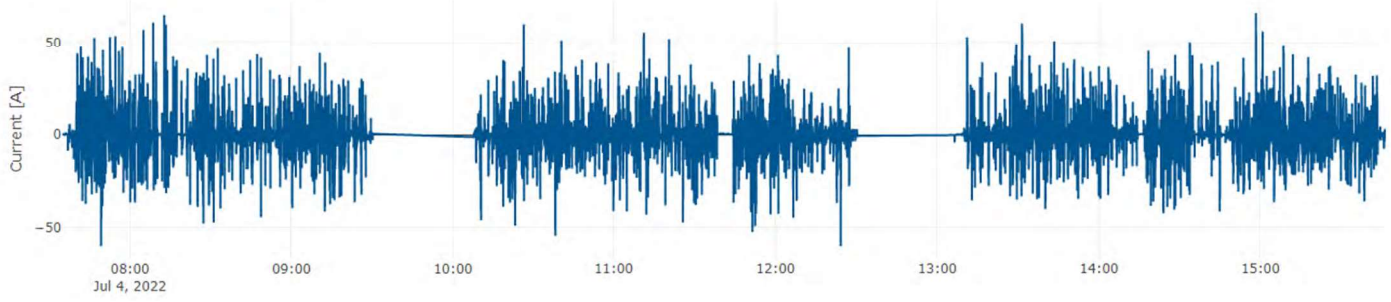

Steering wheel position

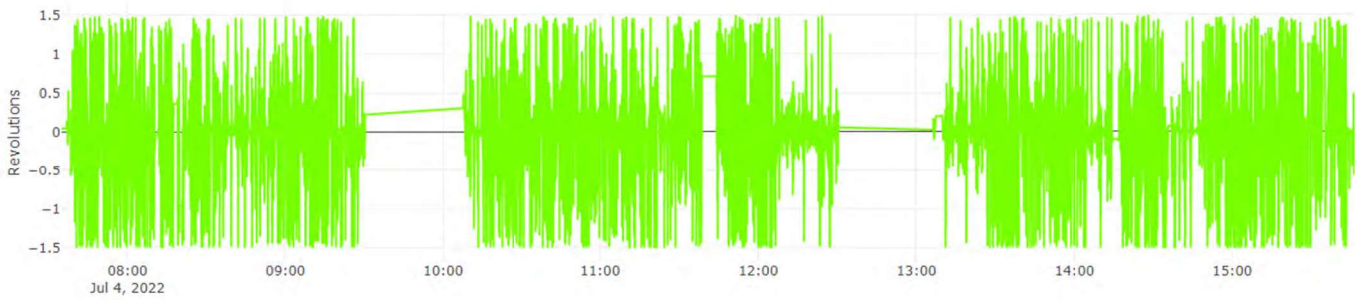

EPAS temperatures

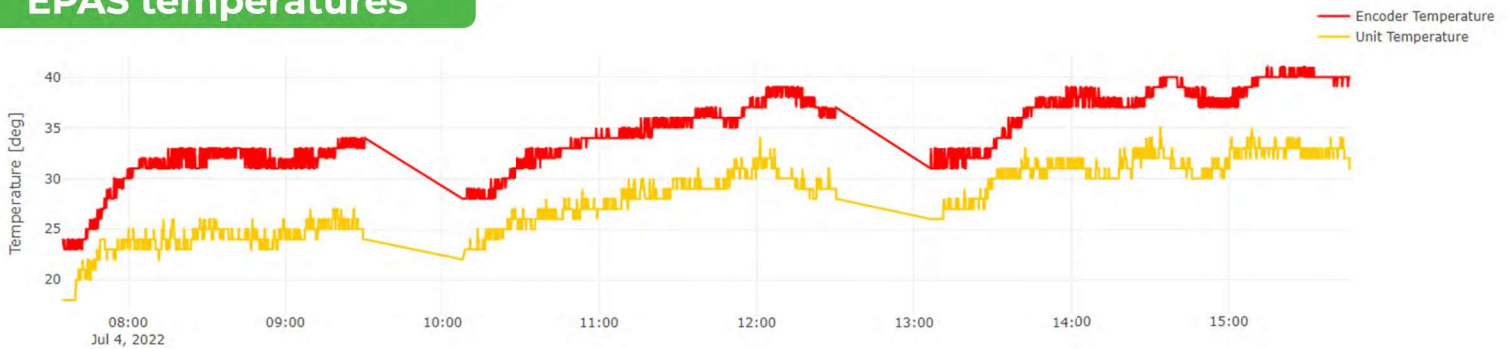

Sensed input torque

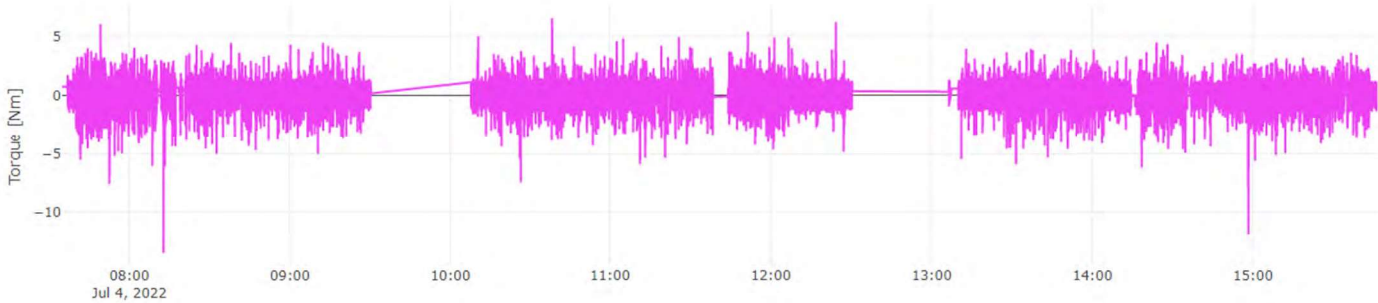

Commanded torque

